

SINGER
151-1

LIST OF PARTS



SINGER**

MACHINE No. 151-1

THE SINGER MANUFACTURING COMPANY

INSTRUCTIONS FOR OILING

To ensure easy running and prevent unnecessary wear of the parts which are in movable contact, the machine requires oiling and when in continuous use, "TYPE B" or "TYPE D" OIL, sold by Singer Sewing Machine Company, should be applied at least twice each day to all oil holes marked "OIL", as instructed in Form 18062.

"TYPE D" OIL should be used when an oil is desired which will produce a minimum of stain on fabrics, even after a long period of storage.

To insure satisfactory results, "TYPE E" THREAD LUBRICANT, sold by Singer Sewing Machine Company, should be used in the thread lubricator which is attached to the top of the machine.

INDEX

	PAGE
ACCESSORIES	16
IRON BASE	16
MACHINE NO. 151-1	7
NUMERICAL LIST OF PARTS	19
OBSOLETE PARTS	16
TAPE HOLDER	16

INSTRUCTIONS FOR ORDERING

In ordering from this list, use **ONLY** the **PART** number in the **FIRST** column.

The number stamped on a Sewing Machine part is in every case the number of the single part only.

Every combination of parts sent out as such has its specific number, which, although not stamped on the parts, must be used when ordering the combination.

Each number always indicates the **SAME PART** in whatever list it appears, or for whatever machine.

The letters after some of the numbers indicate the style of finish only, as follows:

- A. Hardened, Polished and Plated.
- B. Polished and Plated.
- C. Hardened only.
- D. Polished only.
- E. Soft, not Polished.
- F. Hardened and Polished.
- G.
- H. Blued.
- J. Plated only.
- K. Hardened and Plated.
- L. Brass or Gilt.
- M. Oxidized.
- P. Japanned.
- R. Merlized.
- T. Copper-plated.

These letters **MUST BE USED** when they appear in the list, and **AFTER** the number as in the list.

In this series:

- 1 to 1500 and 50001 to 51500 are Screw Numbers.
- 1501 to 1800 are Nut Numbers.
- 1801 to 2000 are Roller Numbers.
- 2001 to 50000 and 52001 and upward are numbers of Machine Parts.

The figures in the second column refer only to the plates, illustrating the parts, and are **NOT TO BE USED** in ordering.

Parts marked with an asterisk (*) are furnished only when repairs are made at factory.

LIST OF PARTS COMPLETE

FOR

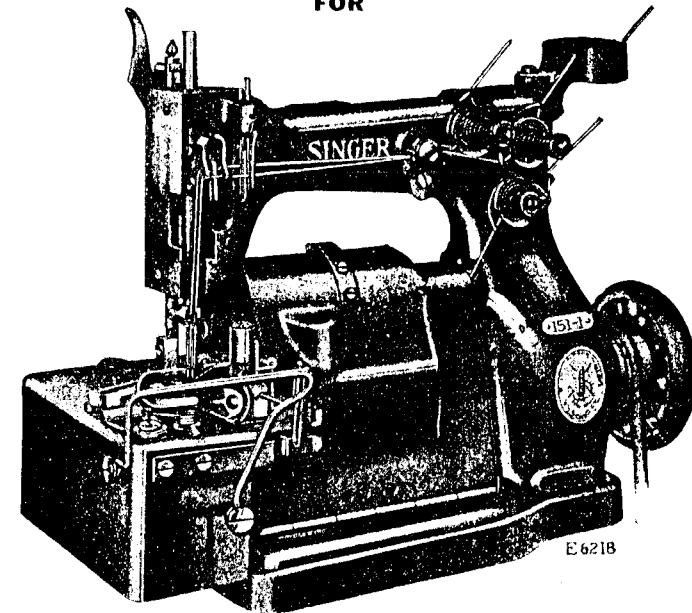

MACHINE No. 151-1

FOR EDGES OF HAT SWEATS. THE MACHINE MAKES AN ORNAMENTAL STITCH AND IS FITTED WITH A FOLDING ATTACHMENT WITH A TUBE, FOR FOLDING THE STRIP, GUIDING AND INSERTING THE REED OR WIRE, AND STITCHING TO THE SWEAT WITH AN OVERSEAMING THREE-THREAD CHAIN STITCH. TWO NEEDLES AND ONE LOOPER. GAUGE $\frac{3}{32}$ INCH. SPEED 2250.

NO.	PLATE	NAME
*129001	— —	Arm, upper and lower (solid) with 6900 and 129022.....
129002	9007	Arm Back Cover.....
	133D 9015	“ “ “ Screw (long).....
	171D 9015	“ “ “ “ (short).....
129003	9007	“ Front Cover.....
129004	— —	“ “ “ 129003 with 129007, 129086, two 207D and four 213E.....
*129005	— —	Arm Front Cover Hinge (left).....
*129006	— —	“ “ “ “ (right).....
129086	9001	Arm Front Cover Hinge complete, Nos. 129005, 129006 and 129085.....
129085	— —	Arm Front Cover Hinge Pin.....

NO.	PLATE	NAME
50231D	9015	Arm Front Cover Hinge Screw.....
129007	9002	“ “ “ Lock Spring.....
207D	9002	“ “ “ “ “ Screw....
213E	9015	“ “ “ “ “ Screw.....
129008	9001	“ Rock Shaft.....
129089	9002	“ “ “ Crank (back) with two 1259c.....
1259c	9002	Arm Rock Shaft Crank (back) Set Screw.
129116	9002	“ “ “ “ (front) with two 1259c.....
1259c	9002	Arm Rock Shaft Crank (front) Set Screw
129009	9001	“ Rotary Shaft.....
129010	9001	“ “ “ Flanged Bushing....
50380c	9015	“ “ “ “ “ Set Screw.....
129011	9002	Arm Rotary Shaft Gear with two 462c....
462c	9002	“ “ “ “ “ Set Screw.....
1415D	9015	“ “ “ “ Oil Plug Screw.....
129012	9001	Balance Wheel, 1 $\frac{3}{4}$ in. pulley, with 435c
435c	9015	“ “ “ “ “ Set Screw.....
129013	9007	Cloth Plate.....
129014	---	Cloth Plate complete, Nos. 7071, 27866, 129013, 129028, 129029 and two 190b
129015	9001	Cloth Plate Extension.....
167D	9015	“ “ “ “ “ Screw.....
9525	9002	“ “ “ “ “ Washer....
50378F	9015	“ “ “ “ “ Screw (long).....
914c	9015	“ “ “ “ “ (short).....
129016	9001	Crank Connecting Rod with 129017 and two 896E.....
*129017	---	Crank Connecting Rod Cap.....
896E	9015	“ “ “ “ “ Screw.....
50276c	9015	“ “ “ “ “ Hinge Screw....
1520E	9015	“ “ “ “ “ “ Nut
129018	9002	Face Plate.....
337D	9002	“ “ “ “ “ Screw.....
38579	9002	Feed Bar with 175F.....
22339	9002	“ “ “ “ “ Hinge Pin.....
175F	9002	“ “ “ “ “ Clamping Screw....
42507	9003	“ “ “ “ “ Connecting Rod with 38588 and two 1057E.....
*38588	---	Feed Connecting Rod Cap.....
1057E	9003	“ “ “ “ “ “ Screw.....
129019	9004	“ “ “ “ “ Dog.....
190D	9004	“ “ “ “ “ “ Screw.....
129020	9003	“ “ “ “ “ Eccentric with two 1258c.....
1258c	9003	“ “ “ “ “ “ Set Screw.....

NO.	PLATE	NAME
129096	9003	Feed Lifting Eccentric with two 1259c....
129021	9003	“ “ “ “ “ Connection.....
1259c	9002	“ “ “ “ “ Lifting Eccentric Set Screw.....
42511	9003	“ “ “ “ “ Regulator.....
1038c	9003	“ “ “ “ “ Adjusting Screw.....
7070	9003	“ “ “ “ “ “ Sleeve
1589c	9003	“ “ “ “ “ “ Thumb Nut.....
2269	9003	Feed Regulator Pin.....
129097	9003	“ “ “ “ “ Rock Shaft.....
*129022	---	“ “ “ “ “ Bracket with 1120c and two 446c.....
690E	9015	Feed Rock Shaft Bracket Screw.....
21509	9003	“ “ “ “ “ Collar with 207K.....
207K	9002	“ “ “ “ “ “ Set Screw.....
42514	9003	“ “ “ “ “ Crank with two 896c....
896c	9015	“ “ “ “ “ “ Clamping Screw
120442	9013	Hat Sweat Folder (lower).....
1423J	9013	“ “ “ “ “ “ Screw.....
120443	9013	“ “ “ “ “ (upper) with 11656 and 120453.....
120453	9013	Hat Sweat Folder (upper) Tube.....
120444	9013	“ “ “ “ “ “ Bracket.....
50043c	9013	“ “ “ “ “ “ Regulating Screw....
120449	9016	“ “ “ “ “ “ Follower.....
120424	---	“ “ “ “ “ “ 120449 with 1425b, 19054 and 120450.....
1425b	9016	Hat Sweat Follower Hinge Screw.....
19054	9016	“ “ “ “ “ “ “ Friction Washer.....
120450	9016	Hat Sweat Follower Holder.....
1425b	9016	“ “ “ “ “ “ “ Hinge Screw
8482	9016	“ “ “ “ “ “ “ “ Washer (lower).....
19021	9016	Hat Sweat Follower Holder Hinge Screw Washer (upper).....
120425	9016	Hat Sweat Follower Spring.....
203b	9016	“ “ “ “ “ “ “ Screw.....
120445	9013	“ “ “ “ “ “ Guide.....
120446	9013	“ “ “ “ “ “ “ Holder.....
11656	9013	“ “ “ “ “ “ “ “ Position Pin..
120447	9013	“ “ “ “ “ “ “ “ Lever (eccentric) with 1422J.....
120448	9013	Hat Sweat Guide Lever Friction Washer.
50357D	9013	“ “ “ “ “ “ “ Hinge Screw....
1422J	9013	“ “ “ “ “ “ “ “ Thumb Screw....
665D	9013	“ “ “ “ “ “ “ “ Screw.....

NO.	PLATE	NAME
120422	—	Hat Sweat Folder with Guide (adjustable) complete, for leather, reed and tape, Nos. 665D, 1423J, 50043C, 50318D, 50357D and 120442 to 120448.
596D	9013	Hat Sweat Folder Screw.
129121	9005	Looper
129024	9005	“ Carrier
129025	9005	“ “ Driving Shaft and Gear
129026	9005	“ “ “ “ Bushing
486C	9005	“ “ “ “ “ Set Screw
1480D	9005	Looper Carrier Driving Shaft Cap Screw
65628	9005	“ “ “ “ Collar with two 460C
460C	9005	Looper Carrier Driving Shaft Collar Set Screw
1386C	9005	Looper Carrier Pitman Ball Screw Stud (left)
1520J	9015	Looper Carrier Pitman Ball Screw Stud (left) Nut
679C	9005	Looper Carrier Pitman Ball Screw Stud (right)
*42524	—	Looper Carrier Pitman Cap (left)
196E	9005	“ “ “ “ “ Screw
*42525	—	“ “ “ “ “ (right)
196E	9005	“ “ “ “ “ Screw
*42526	—	“ “ “ “ End Bearing (left)
*42527	—	“ “ “ “ “ (right)
42593	9005	“ “ “ “ Head (left), Nos. 1386C, 42524, 42526 and two 196E
42594	9005	Looper Carrier Pitman Head (right), Nos. 679C, 42525, 42527 and two 196E
129087	9005	Looper Carrier Pitman Rod
1682J	9005	“ “ “ “ Nut (left)
1550J	9005	“ “ “ “ “ (right)
129088	9005	Looper Carrier Pitman complete, Nos. 1550J, 1682J, 42593, 42594 and 129087
129027	9005	Looper Carrier Rock Shaft
32152	9006	“ “ “ “ Collar with two 889C
889C	9006	Looper Carrier Rock Shaft Collar Set Screw
129098	9006	Looper Carrier Rock Shaft Crank (forked) with 142E and 172E
142E	9006	Looper Carrier Rock Shaft Crank Adjusting Screw

NO.	PLATE	NAME
172E	9006	Looper Carrier Rock Shaft Crank Clamping Screw
50951C	9006	Looper Carrier Screw Stud
199C	9006	“ “ “ “ Cap Screw
1684C	9006	“ “ “ “ Nut
129028	9007	“ Gate with 624C
27866	9006	“ “ Hinge Pin
624C	9006	“ “ “ “ Set Screw
129029	9006	“ “ Lock Spring
190D	9004	“ “ “ “ Screw
7071	9006	“ “ “ “ “ Washer
50253D	9006	“ Screw
129031	9006	Needle Bar
129111	—	Needle Bar complete, Nos. 129031, 129035, 129101 and 129112
9830	9006	Needle Bar Bushing
50150C	9006	“ “ “ “ Set Screw
129117	9006	“ “ Connecting Link
24011	9006	“ “ “ “ Stud with 207E
207E	9002	“ “ “ “ “ Clamping Screw
129112	9006	Needle Clamp with 209E
129101	9006	“ “ Gib
129035	9006	“ “ “ “ Pin
209F	9006	“ “ “ “ Screw
129037	9008	Oil Cup, for oiling silk thread
129038	9008	“ “ Pad (felt)
50152D	9008	“ “ “ “ Screw
129102	9008	“ “ for 129103
129103	9008	Oil Cup (hinged) complete, for oiling sweat band, Nos. 64622, 129102, 129104 and 129105
129104	9008	Oil Cup Bracket
64622	9008	“ “ Hinge Pin
129105	9008	“ “ Pad (felt)
129039	9008	Presser Bar
129040	9008	“ “ Guide Bracket with 223E and 50150C
223E	9008	Presser Bar Guide Bracket Adjusting Screw
129041	9008	Presser Bar Guide Bracket Guide
457C	9008	“ “ “ “ “ Set Screw
50150C	9006	“ “ “ “ “ Set Screw
129042	9008	“ “ Lifter
999F	9008	“ “ “ “ Hinge Screw
1002F	9008	“ “ “ “ Screw Stud

NO.	PLATE	NAME
38617	9008	Presser Bar Spring.....
19035	9008	" " " Bracket.....
129043	9004	" Foot with 198D and 129070.....
185D	9004	" " Screw.....
50278D	9015	Pressure Regulating Thumb Screw.....
120423	9016	Tape Guide.....
50318D	9016	" " Set Screw.....
2102	9009	Tension (under thread) Disc.....
1560c	9009	" " " Regulating Thumb Nut.....
916c	9009	Tension (under thread) Screw Stud.....
10148	9009	" " " Spring.....
22430	9009	" " " Thread Eyelet
57076	9009	" " " Guide...
2102	9009	" (upper thread) Disc.....
1560c	9009	" " " Regulating Thumb Nut.....
50261c	9009	Tension (upper thread) Screw Stud.....
52570	9009	" " " Spring.....
5983	9009	" " " " Washer (felt).....
57076	9009	Tension (upper thread) Thread Guide (double).....
17547	9009	Tension (upper thread) Thread Guide (single).....
129044	9009	Thread (under) Eyelet (back).....
904K	9009	" " " " Set Screw
129045	9009	" " " (front).....
460c	9005	" " " " Set Screw
129110	9009	" " Nipper Spring (lower)...
129046	9009	" " " " (upper)...
217D	9009	" " " " Screw.....
129091	9009	" " Take-up with 465c.....
465c	9009	" " " Set Screw.....
129092	9009	" " " Staple with two each 590D and 38393.....
129047	9009	Thread (under) Take-up Staple Bracket
50073D	9009	" " " " " "
		Screw.....
217D	9009	Thread (under) Take-up Staple Screw....
38393	9009	" " " " Thread Guard.....
590D	9009	Thread (under) Take-up Staple Thread Guard Screw.....
42585	9010	Thread (under) Take-up Stripper.....
190D	9004	" " " " Screw

NO.	PLATE	NAME
17022	9010	Thread (under) Take-up Stripper Screw Washer.....
129093	9010	Thread (under) Take-up Thread Guard
240D	9010	" " " " "
		Screw.....
129048	9010	Thread (upper) Guide (left).....
460c	9005	" " " " Screw.....
129049	9010	" " " (right).....
460c	9005	" " " " Screw.....
129050	9010	" " Nipper Cam with two 454c.....
454c	9010	Thread (upper) Nipper Cam Set Screw...
21032	9010	" " " Disc.....
129051	9010	" " " " Spacing Washer.....
50952c	9010	Thread (upper) Nipper Screw Stud.....
129052	9010	" " " " " Bush- ing.....
1623E	9010	Thread (upper) Nipper Screw Stud Bush- ing Lock Nut.....
129053	9010	Thread (upper) Nipper Screw Stud Nut with 19445.....
19445	9010	Thread (upper) Nipper Screw Stud Nut Position Pin.....
129054	9010	Thread (upper) Nipper Screw Stud Nut Spring.....
129055	9010	Thread (upper) Nipper Thread Guide
217D	9009	" " " " " "
		Screw.....
129056	9010	Thread (upper) Take-up.....
129057	9010	" " " " Holder with 50311c.....
50311c	9010	Thread (upper) Take-up Holder Set Screw.....
233D	9010	Thread (upper) Take-up Screw.....
129058	9010	" " " Stripper.....
218E	9010	" " " " Screw..
129059	9010	" Covering Finger (back).....
129060	9010	" " " " Driving Lever with 1835 and 50302b.....
52863	9010	Thread Covering Finger (back) Driving Lever Ball Stud.....
50302D	9010	Thread Covering Finger (back) Driving Lever Ball Stud Set Screw.....
129062	9010	Thread Covering Finger (back) Driving Lever Hinge Stud.....

IRON BASE

NO.	PLATE	NAME
129084	9007	Machine Base with 129113, three wood screws $\frac{3}{4}$ in. No. 8 and four 32246....
32246	9012	Machine Cushion (felt) small.....
129113	9012	" " " large.....

ACCESSORIES

NO.	PLATE	NAME
50280J	9014	Machine Base Thumb Screw.....
9842	9012	" " " " Washer.....
120342	9014	Oiler (copper plated) with 120343.....
120343	9014	" Spout, $3\frac{1}{2}$ in. long.....
120440	9014	Screw Driver (large).....
26485	9014	" " (small).....
120341	9014	Tweezers (curved).....
10875	9014	Wrench for 1520 and 1623.....
42850	9014	" " 1550, 1682 and 1735.....
129090	9014	" " 1772.....

TAPE HOLDER

(10 Inch Disc)

NO.	PLATE	NAME
35908	—	Disc.....
35909	6479	" 35908 with 35910 and five 4604....
35910	6479	" Hub.....
4604	9012	" Rivet.....
35911	9012	Shaft.....
35912	9012	" Bushing with 35913.....
35913	—	" " Guide.....
793D	9012	" " Thumb Screw.....
35914	9012	Spindle.....
35915	6479	Stand.....
35916	9012	Tension Spring.....
288D	9012	" " Thumb Screw.....
35917	—	Tape Holder (10 in. disc) complete, Nos. 288D, 793D, 35909, 35911, 35912, 35914 to 35916 and three wood screws 1 in. No. 10.....

OBSOLETE PARTS

NO.	PLATE	NAME
129023	9005	Looper with 242D and 129030, use 129121
129030	9005	" Loop Retainer for 129023.....

NO.	PLATE	NAME
242D	9005	Looper Loop Retainer Screw for 129023
129032	—	Needle Bar complete, Nos. 129031 and 129033 to 129035.....
129099	—	Needle Bar complete, Nos. 129031, 129035, 129100 and 129101, use 129111
129033	9006	Needle Clamp with 207D, for 129032....
129100	9006	" " " 209E, for 129099, use 129112.....
129034	9006	Needle Clamp Gib with 129036, for 129032.....
207D	9002	Needle Clamp Screw for 129033.....
129036	9006	" " Thread Retainer for 129034
129095	9006	" Loop Guard.....
129072	9012	Thread Covering Finger (front) Driving Lever with 904C.....
129074	9012	Thread Covering Finger (front) Holder
129075	9012	" " " " " " Spring.....
904C	9009	Thread Covering Finger (front) Holder Spring Set Screw for 129072.....

PLATE 6479—ONE-FOURTH SIZE

35909

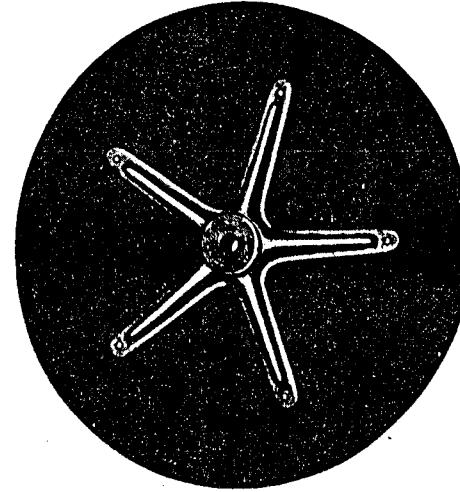

35910

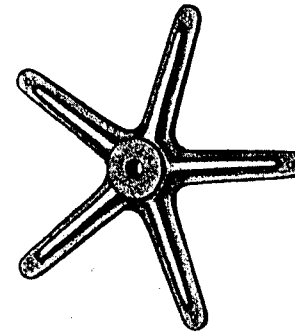

35915

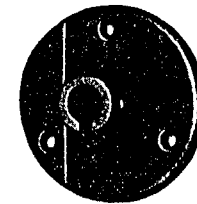

SINGER Needles should be used
in SINGER Machines
These Needles and their Containers
are marked with the
Company's Trade Mark "SIMANCO.**" 1

Needles in Containers marked
"FOR SINGER MACHINES"
are NOT SINGER made needles. 2

PLATE 9001—ONE-HALF SIZE

129009



129016



129086

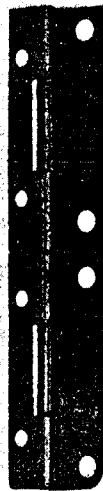

129078 129008



129012

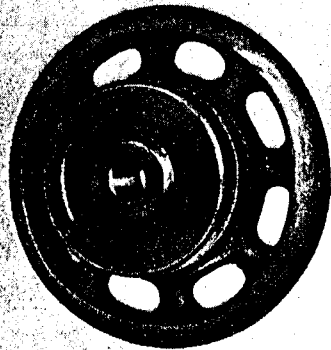

129010

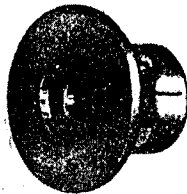

129015

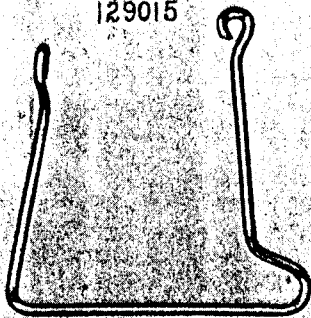

129077

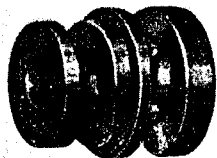

PLATE 9002—FULL SIZE

129018



22339



38579

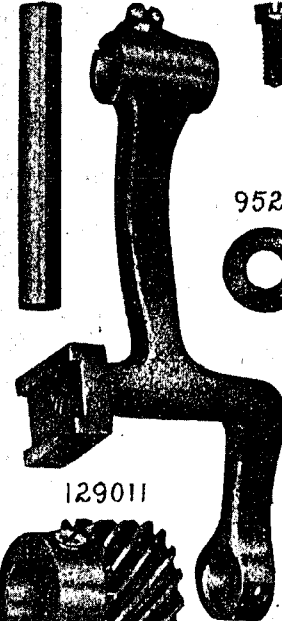

175



9525



337



129011

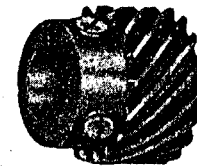

129007



129089

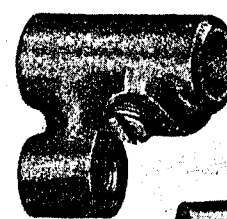

129116

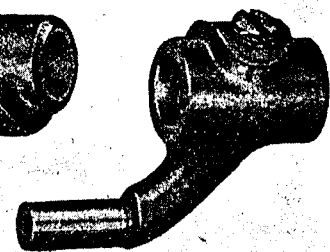

207



1259



462



PLATE 9003—FULL SIZE

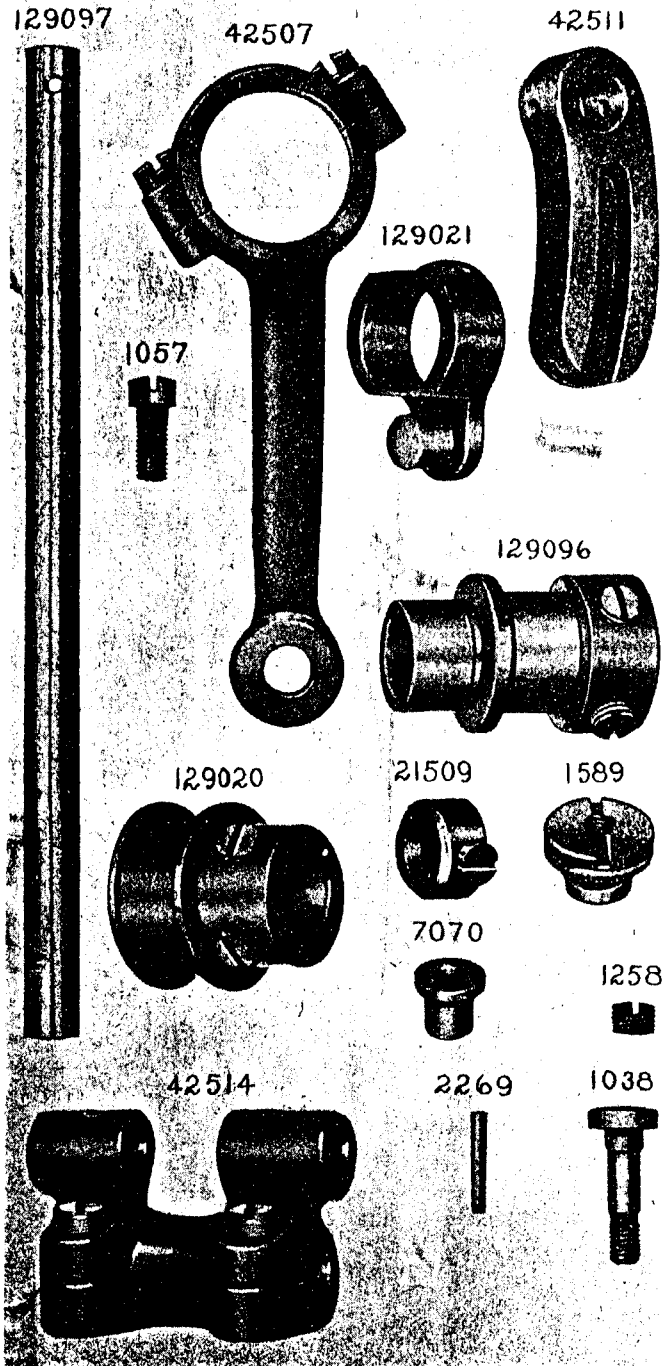

PLATE 9004—FULL SIZE

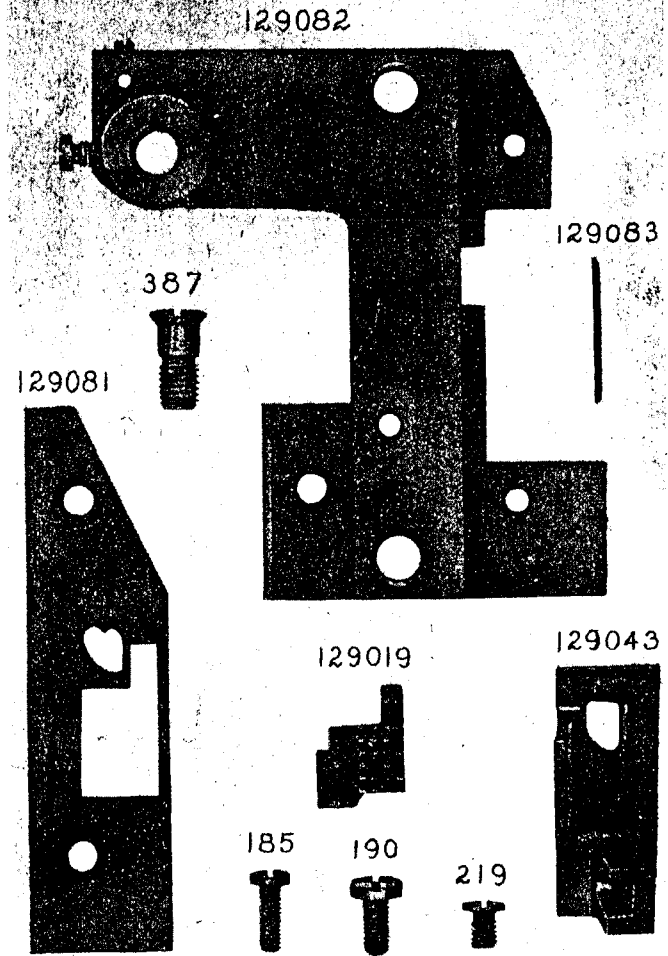

PLATE 9005—FULL SIZE

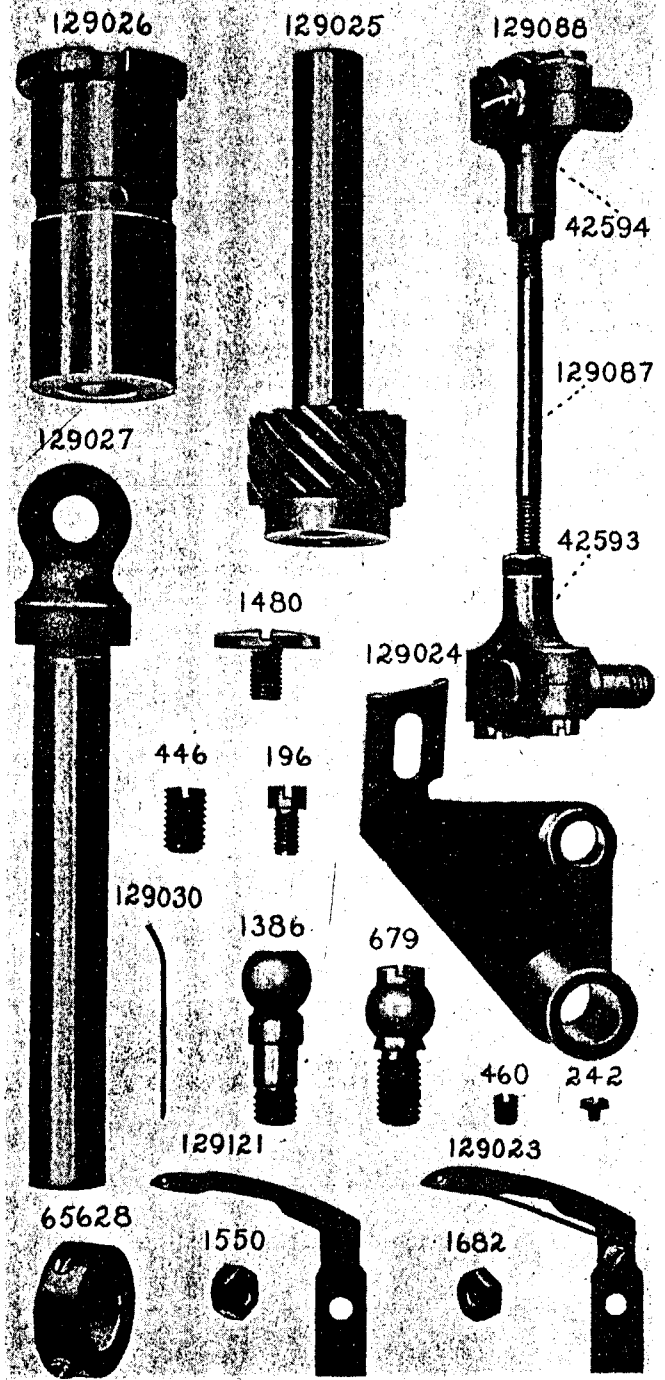

PLATE 9006—FULL SIZE

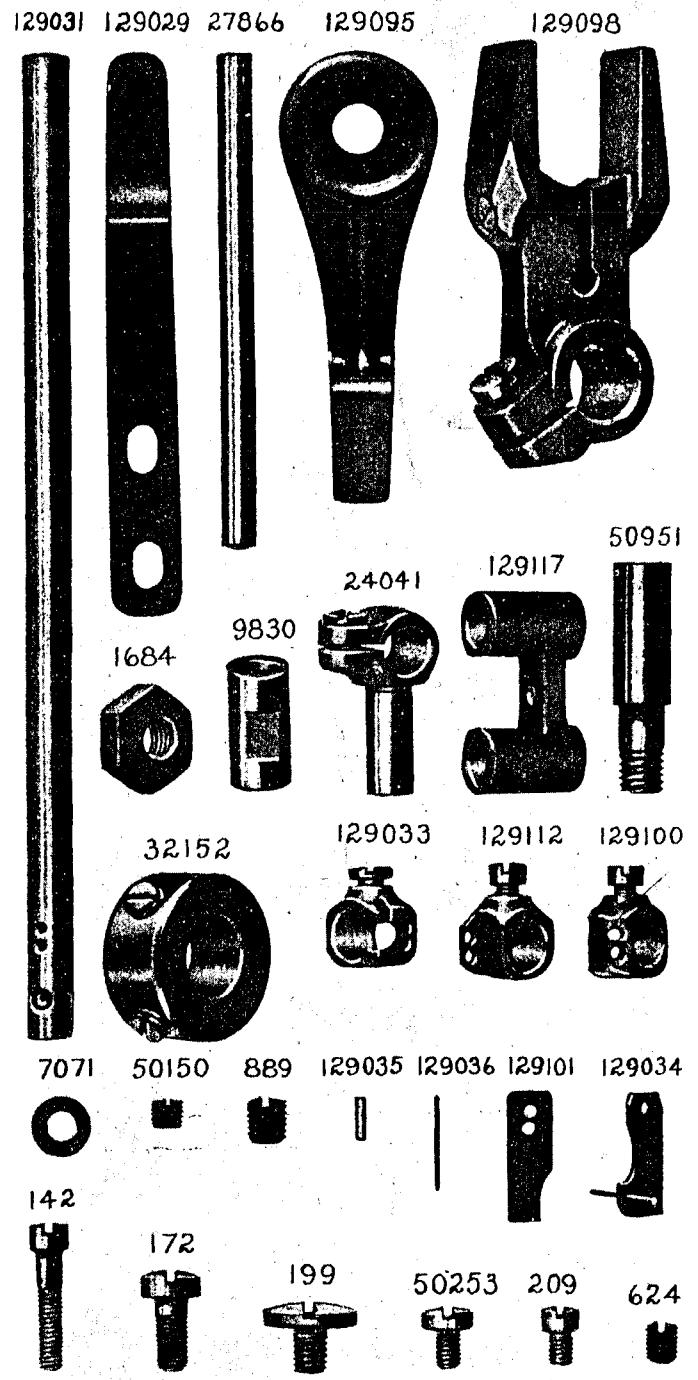

PLATE 9007—ONE-FOURTH SIZE

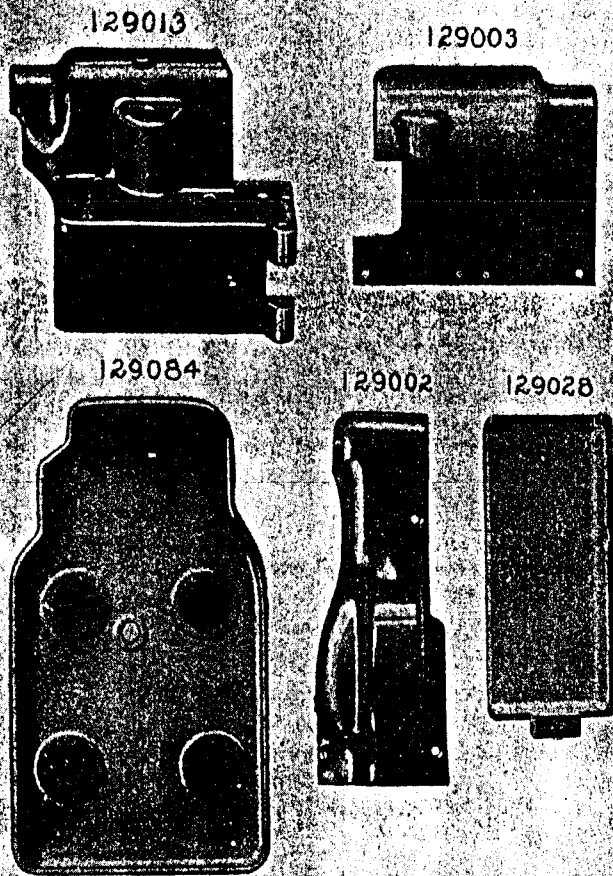

PLATE 9008—FULL SIZE

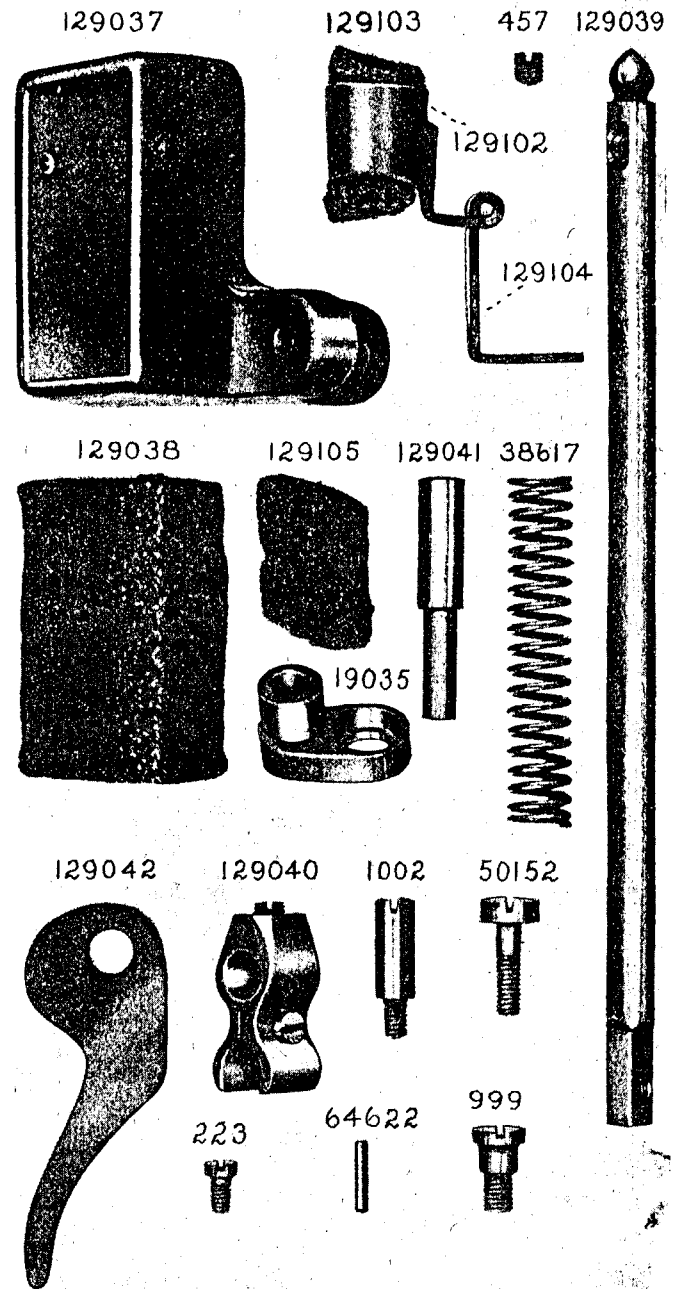

PLATE 9009—FULL SIZE

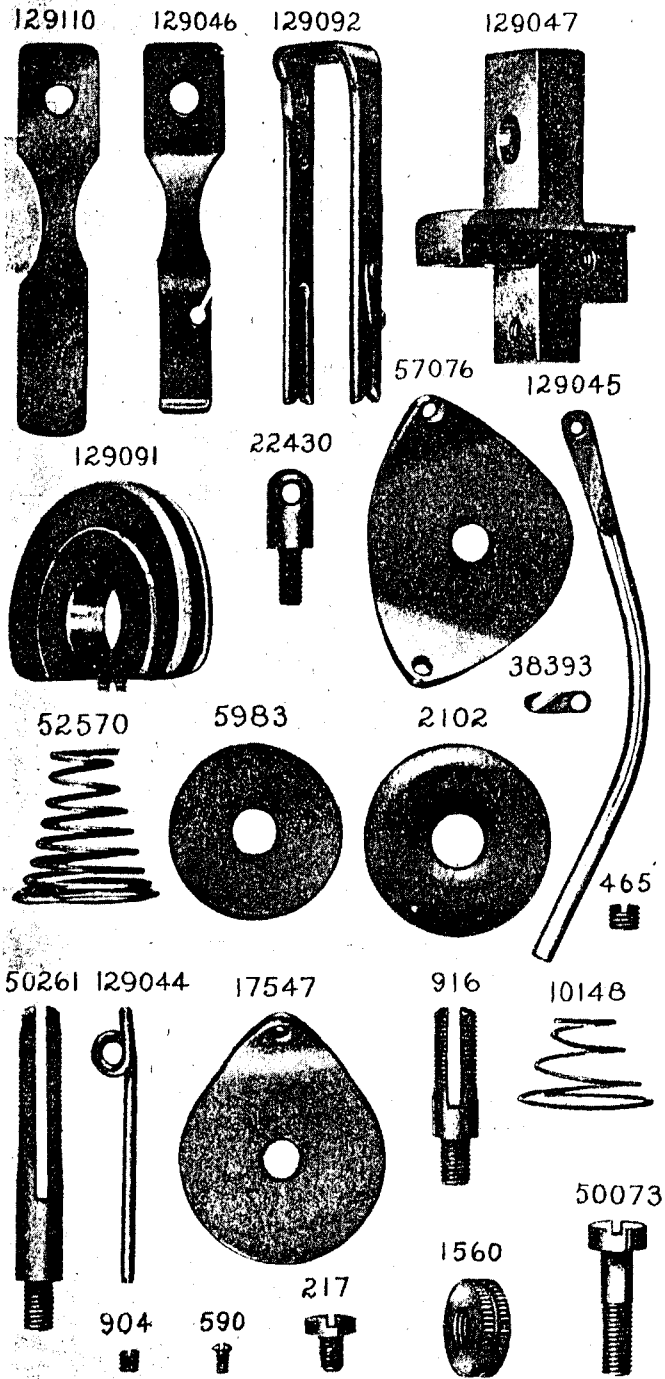

PLATE 9010—FULL SIZE

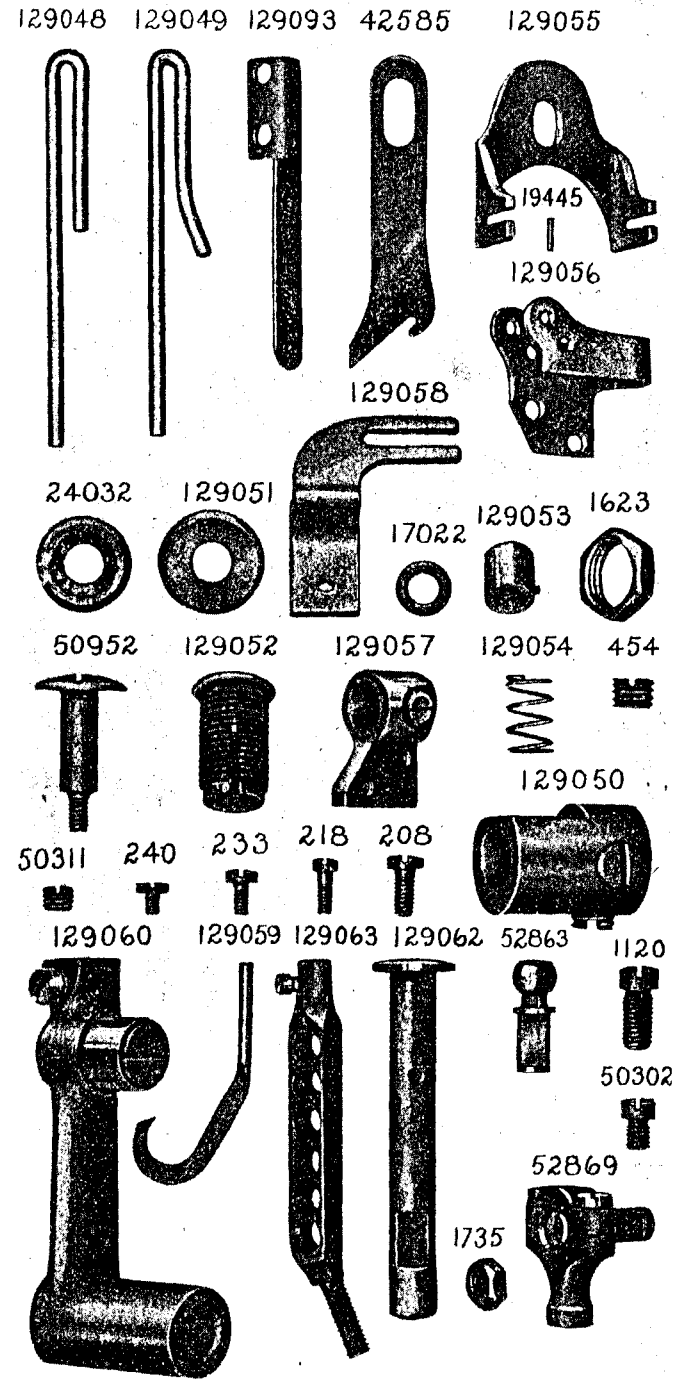

PLATE 9011—FULL SIZE

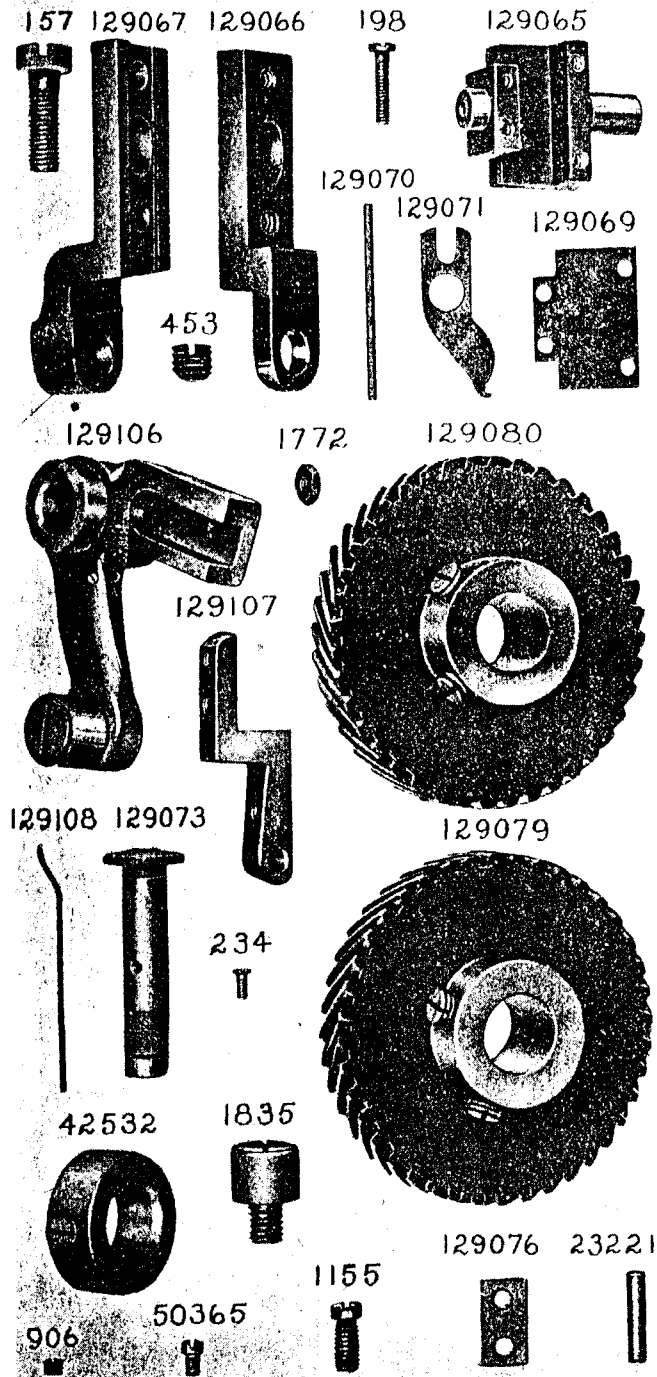

PLATE 9012—FULL SIZE

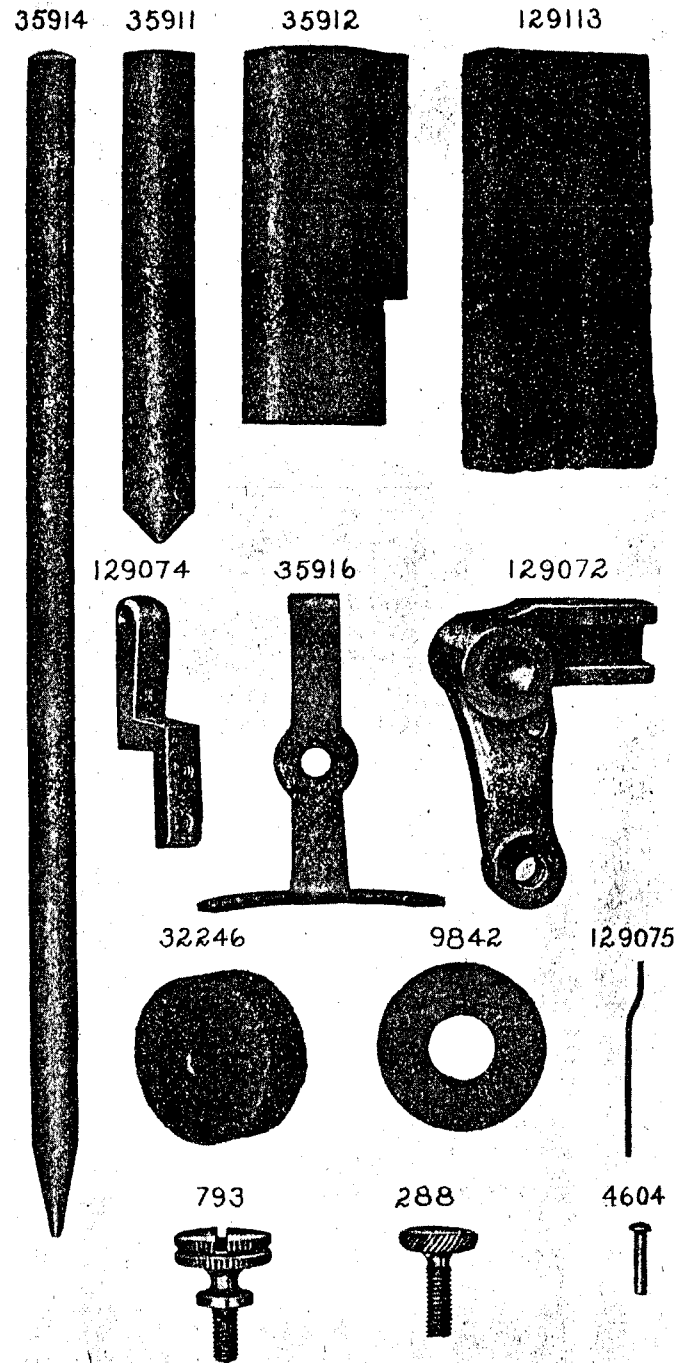

PLATE 9013—FULL SIZE

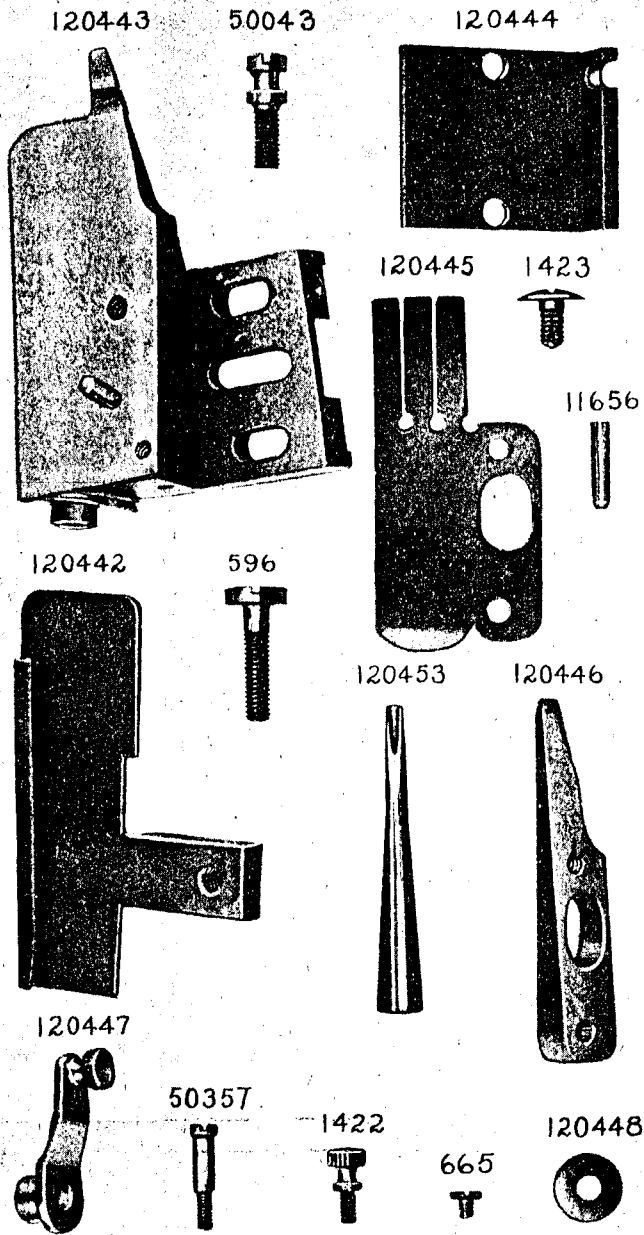

PLATE 9014—ONE-HALF SIZE

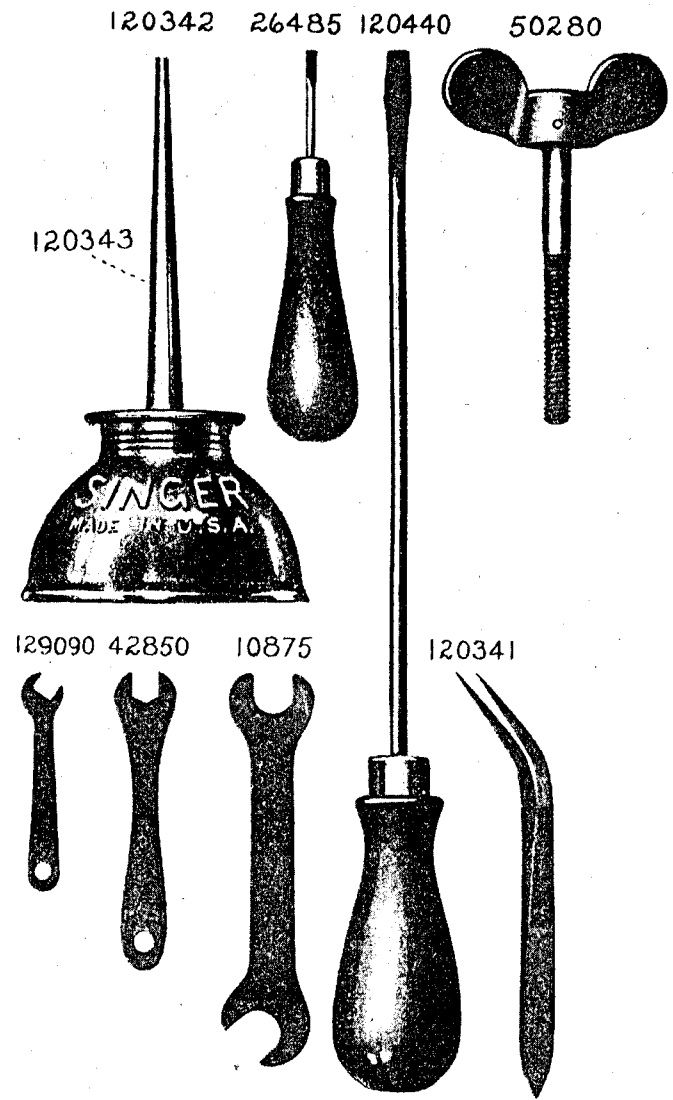

PLATE 9015—FULL SIZE

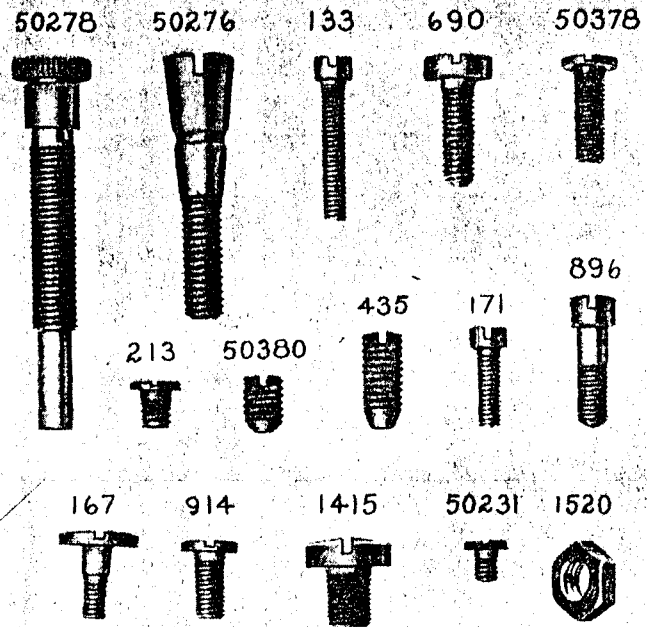

PLATE 9016—FULL SIZE

